

FlarmBat

Portable PowerFlarm device

Version 1.13



LXNAV d.o.o. • Kidričeva 24, 3000 Celje, Slovenia • tel +386 592 33 400 fax +386 599 33 522
info@lxnav.com • www.lxnav.com

1	Important Notices	4
1.1	Limited Warranty	4
1.2	Battery information	5
1.2.1	Disposal of Old Electrical & Electronic Equipment	5
1.2.2	Disposal of waste batteries	6
2	Packing Lists	7
3	Basics	8
3.1	LXNAV FlarmBat display at a Glance	8
3.1.1	LXNAV FlarmBat features	9
3.1.2	Interfaces	9
3.1.3	Technical Data	9
3.2	Hardware variants	9
3.2.1	PowerFlarm module	9
3.2.2	Secondary PowerFlarm module	9
3.2.3	ADS-B module	10
4	System Description	11
4.1	Description of Flarm (PowerFlarm) Led Display	11
4.1.1	Status LEDs	11
4.1.2	Battery and charger status LEDs	11
4.1.3	Horizontal direction LEDs	12
4.1.4	Vertical direction LEDs	12
4.1.5	Distance to the target indicator	12
4.1.6	SD card socket	12
4.1.7	Push Button	12
4.1.8	ALS	12
4.2	Powering up FlarmBat	13
4.3	Startup sequence	13
4.4	Shutting down FlarmBat	13
4.5	Normal operation	13
4.5.1	WARNING Modes:	13
4.5.2	NEAREST Mode:	13
4.5.2.1	Multi target in nearest modus	13
4.5.3	Obstacle warning	14
4.5.4	Undirected PCAS warning	14
4.6	Setting up FlarmBat	15
4.7	Other indications	16
4.7.1	IGC-file download onto SD-card (1)	17
4.7.2	Running Flarm firmware update from SD-card (2)	17
4.7.3	Obstacle database update from SD-card (3)	17
4.7.4	Diagnostic dump (4)	17
4.7.5	Restore file system (5)	17
4.7.6	Internal consistency check (6)	18
4.7.7	Error codes from flarm	18
4.8	Wiring	20
4.8.1	FlarmBat pinout	20
4.8.1.1	FlarmBat – FlarmView	21
4.8.1.2	FlarmBat – FlarmLED	21
4.8.1.3	FlarmBat – FlarmLED – Oudie	21
4.8.1.4	FlarmBat – FlarmView – Sxxx Vario	22
4.8.1.5	FlarmBat – LX9xxx – FlarmView	22
4.8.2	Flarm antenna wiring	22

4.9	Firmware update	23
4.9.1	ADS-B firmware update via Flash Loader	23
4.10	Configuring FlarmBat	24
4.10.1	Configuring FlarmBat settings PowerFlarmConfig	24
4.10.2	FlarmBat configuration by using Flarm configuration tool	24
4.11	Saving flight on the micro SD card	28
5	Revision History	29

1 Important Notices

The LXNAV system is designed for VFR use only as an aid to prudent navigation. All information is presented for reference only. Terrain, airports and airspace data are provided only as an aid to situation awareness.

Information in this document is subject to change without notice. LXNAV reserves the right to change or improve their products and to make changes in the content of this material without obligation to notify any person or organization of such changes or improvements.



A Yellow triangle shows parts of the manual which should be read very carefully and are important for operating the system.



Notes with a red triangle describe procedures which are critical and may result in loss of data or any other critical situation.



A bulb icon shows when a useful hint is provided to the reader.

1.1 Limited Warranty

This LXNAV product is warranted to be free from defects in materials or workmanship for two years from the date of purchase. Within this period, LXNAV will, at its sole discretion, repair or replace any components that fail in normal use. Such repairs or replacement will be made at no charge to the customer for parts and labor, provided that the customer shall be responsible for any transportation cost. This warranty does not cover failures due to abuse, misuse, accident, or unauthorized alterations or repairs. LXNAV Instrument displays damaged by direct or magnified sunlight are not covered under warranty.

THE WARRANTIES AND REMEDIES CONTAINED HEREIN ARE EXCLUSIVE AND IN LIEU OF ALL OTHER WARRANTIES EXPRESSED OR IMPLIED OR STATUTORY, INCLUDING ANY LIABILITY ARISING UNDER ANY WARRANTY OF MERCHANTABILITY OR FITNESS FOR A PARTICULAR PURPOSE, STATUTORY OR OTHERWISE. THIS WARRANTY GIVES YOU SPECIFIC LEGAL RIGHTS, WHICH MAY VARY FROM STATE TO STATE.

IN NO EVENT SHALL LXNAV BE LIABLE FOR ANY INCIDENTAL, SPECIAL, INDIRECT OR CONSEQUENTIAL DAMAGES, WHETHER RESULTING FROM THE USE, MISUSE, OR INABILITY TO USE THIS PRODUCT OR FROM DEFECTS IN THE PRODUCT. Some states do not allow the exclusion of incidental or consequential damages, so the above limitations may not apply to you. LXNAV retains the exclusive right to repair or replace the unit or software, or to offer a full refund of the purchase price, at its sole discretion. SUCH REMEDY SHALL BE YOUR SOLE AND EXCLUSIVE REMEDY FOR ANY BREACH OF WARRANTY.

To obtain warranty service, contact your local LXNAV dealer or contact LXNAV directly.

1.2 Battery information

A rechargeable battery power the FlarmBat. The battery can be charged and discharged hundreds of times, but it will eventually wear out. Only use the approved battery and recharge your battery only with approved chargers.

When not in use, unplug the charger from the electrical plug and the device. Do not leave a fully charged battery connected to a charger, as overcharging may shorten its life. If left unused, a fully charged battery will lose its charge over time. Use the battery only for its intended purpose. Never use a charger or a battery that is damaged.

If the battery pack is mishandled, the battery pack can burst, cause a fire or even chemical burns. Observe the following precautions.

- Do not disassemble.
- Do not crush and do not expose the battery pack to any shock or force such as hammering, dropping, or stepping on it.
- Do not short circuit and do not allow metal objects to come into contact with the battery terminals.
- Do not expose to high temperature above 60°C (140°F) such as in direct sunlight or in a glider parked in the sun.
- Do not incinerate.
- Do not handle damaged or leaking lithium ion batteries.
- Be sure to charge the battery pack using the supplied battery charger or a device that can charge the battery pack.
- Keep the battery pack out of the reach of (small) young children.
- Keep the battery pack dry.
- Replace the battery pack only with the same or equivalent type recommended by LXNAV.
- Dispose of used battery packs promptly as described in these instructions.



1.2.1 Disposal of Old Electrical & Electronic Equipment

(Applicable in the European Union and other European countries with separate collection systems)



This symbol on the product or on its packaging indicates that this product shall not be treated as household waste. Instead it shall be handed over to the applicable collection point for the recycling of electrical and electronic equipment. By ensuring this product is disposed of correctly, you will help prevent potential negative consequences for the environment and human health, which could otherwise be caused by inappropriate waste handling of this product. The recycling of materials will be a help to conserve natural resources. For more detailed information about recycling of this product, please contact your local Civic Office, your household waste disposal service, or the shop where you purchased the product.

1.2.2 Disposal of waste batteries

(Applicable in the European Union and other European countries with separate collection systems)



This symbol on the battery or on the packaging, indicates that the battery provided with this product shall not be treated as household waste. By ensuring these batteries are disposed of correctly, you will help prevent potentially negative consequences for the environment and human health, which could otherwise be caused by inappropriate waste handling of the battery. The recycling of the materials will help to conserve natural resources.

In case of products that for safety, performance or data integrity reasons, require a permanent connection with an incorporated battery, this battery should be replaced by a qualified service staff only. To ensure that the battery will be treated properly, hand over the product at end-of-life to the applicable collection point for the recycling of electrical and electronic equipment. For all other batteries, please view the section on how to remove the battery from the product safely. Hand the battery over to the applicable collection point for the recycling of waste batteries. For more detailed information about recycling of this product or battery, please contact your local Civic Office, your household waste disposal service or the shop where you purchased the product.

(Applicable for Customers in the U.S.A. and Canada)



Lithium-Ion batteries are recyclable. You can help preserve our environment by returning your used rechargeable batteries to the collection and recycling location nearest you. For more information regarding recycling of rechargeable batteries, call toll free 1-800-822-8837, or visit <http://www.rbrcc.org/>



Do not handle damaged or leaking Lithium-Ion batteries.

2 Packing Lists

- FlarmBat
- Flarm antenna (1)
- 2nd Flarm antenna - optional
- Power cable
- ADS-B antenna – optional
- Micro SD card with manual

3 Basics

3.1 LXNAV FlarmBat display at a Glance

An ideal club compact portable standalone device based on PowerFLARM technology. It comes with an integrated FlarmLED indicator, a built-in Bluetooth module which works with Android and iOS, internal battery up to 10h, GPS module and an option of an IGC flight recorder with internal pressure sensor.

It's a collision avoidance device, designed for gliders as well as for other participants in the air. FLARM® is in widespread use and features include:

- Display of nearby Flarm traffic with warning visually and acoustically of approaching other aircraft or fixed obstacles (where database has been installed)
- intelligent motion prediction which minimizes nuisance alarms and supports situational awareness
- integration with over 50 compatible products by other manufacturers (e.g. PDA moving maps) through open serial port protocol
- SD Card for easy uploads and downloads, IGC-format flight recording and OLC-approval
- based on award-winning original FLARM® design, endorsed by FAI, IGC/OSTIV and EASA (AMC Part 21, Part M)
- optional diamond-level IGC-approval with/without engine noise sensor (ENL)
- a typical radio range that can be verified with online radio range analyser
- powerful 72-channel high-precision uBlox NEO8-GPS module
- full compatibility with wide range of Flarm-licensed products
- operation on a license-free radio band, not based on transponder technology
- small size and simple installation

FlarmBat is available in 5 variants:

1. FlarmBat with Flight recorder (Not approved by IGC), with enabled SAR (search and rescue) function
2. FlarmBat with IGC approved Flight recorder (Up to Diamonds) and SAR function
3. FlarmBat with IGC approved Flight recorder (Up to Diamonds), Engine noise sensor and SAR function
4. RFB – second Flarm antenna (dual antenna diversity) -available for all versions (Non IGC, IGC and IGC ENL)
5. ADS-B module as an option

3.1.1 LXNAV FlarmBat features

- extremely bright bicolor LEDs
- pushbutton on FlarmLED, to adjust some settings
- NEAR mode function
- adjustable baud rate on each comm. port
- adjustable brightness of the screen
- Low current consumption
- Distance indicator
- Built in battery for 12 hours of independent working (including 2nd flarm receiver and ADSB receiver). *Without ADSB and 2nd flarm receiver, may take longer.*

3.1.2 Interfaces

- 2 x Serial RS232 input/output
- pushbutton
- 12 bicolor LEDs for direction
- 5 LEDs for vertical angle
- 3 LEDs for GPS, Rx and Tx indication
- 3 LEDs for battery and charger status
- LED distance indicator

3.1.3 Technical Data

- Power input 8-36V DC
- Consumption 62mA@12V (750mW) – when battery is full
- Consumption 500mA@12V (6W) – when battery is empty
- Weight 240g
- Dimensions: 105mm x 80mm x 35mm

3.2 Hardware variants

FlarmBat can be configured in many variants:

- With primary PowerFlarm module (standard)
- With secondary PowerFlarm module (2 antennas, optional)
- With ADS-B receiver (optional)

3.2.1 PowerFlarm module

All FlarmBats have as a standard built in one PowerFlarm receiver, which can receive data from other PowerFlarm/Flarm equipped aircrafts.

3.2.2 Secondary PowerFlarm module

Is optional and is designed for second antenna, to be installed in the bottom of the aircraft. With second antenna, user gets much wider angle of view, not just horizontally, but also vertically.



2nd PowerFlarm module can be retrofitted into FlarmBats.

3.2.3 ADS-B module

FlarmBat device has a possibility to have an internal ADS-B module. ADS-B module is not a standard part of the FlarmBat, therefore when ordering you have to order FlarmBat with ADSB.

With ADS-B you will see all traffic equipped with mode S transponders.



ADS-B module can be retrofitted into FlarmBats.

4 System Description

4.1 Description of Flarm (PowerFlarm) Led Display

It consists of 5 main parts:

- Status LEDs
- Horizontal direction LEDs
- Vertical direction LEDs
- Push button
- Beeper
- ALS (Ambient light sensor)

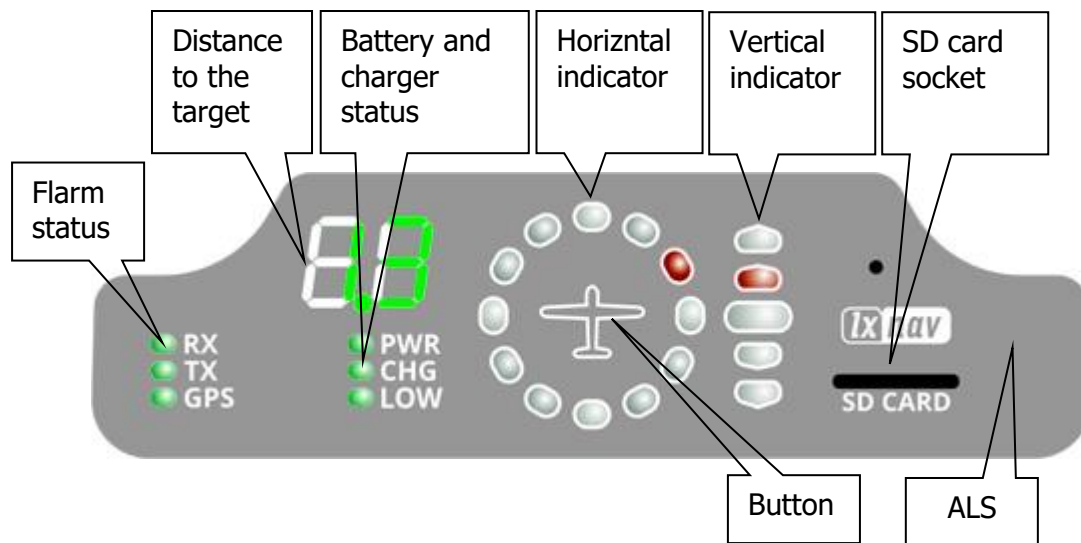

4.1.1 Status LEDs

Status LEDs indicates if PowerFlarm receiver receives any data, transmits data and GPS status.

RX status led indicates that PowerFlarm is receiving something from other Flarm units.

TX status led indicates that Flarm is transmitting data.

GPS status led has 3 different modes:

- Fast blinking mode, means, that Flarm Led does not receive anything over serial bus (probably needs to set correct baud rate)
- Slow blinking means, that GPS status is BAD
- Solid light means, that GPS status is OK.

4.1.2 Battery and charger status LEDs

All LED's are in green color.

- **PWR** LED is ON, when unit is powered on.
- **CHG** LED is on, when internal battery is charging
- **LOW** LED is on, when internal battery voltage is low



Internal battery is charging only, when FlarmBat is powered on and connected to external power.

4.1.3 Horizontal direction LEDs

They are in yellow or red color.

12 horizontal LEDs are indicating the direction of threat.

Example shows threat from front right side (2'o clock)

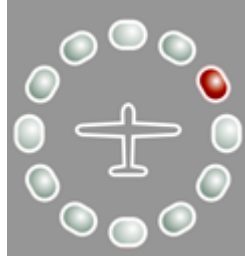

4.1.4 Vertical direction LEDs

They are in yellow color.

LEDs are describing vertical angle of threat divided by 14°

Example shows that threat is approximately 14° above us, top led threat will be 28° or higher above us.



Resolution of vertical indicator can be set in the setup

4.1.5 Distance to the target indicator

It is in green color. In normal operation, it shows distance to the target in units, selected in setup menu.



4.1.6 SD card socket

SD card can be used for PowerFlarm configuration and for storing flights. If SD card is empty, all flights stored will be copied to SD card after power on.

4.1.7 Push Button

With push button we can adjust volume of beep, turning on/off near mode or adjust initial settings of the display. Initial settings can be configured in setup.

4.1.8 ALS

Is Ambient light sensor. If Brightness is set to automatic, it will be adjusted depending on ambient light sensor. More sun light will be, brighter will be LEDs.

4.2 Powering up FlarmBat

LXNAV FlarmBat Powers ON after pressing the button. First it passes boot up sequence with test of all LEDs and short beep, shows version of FlarmBat display firmware (yellow horizontal led indicates major version, distance indicator shows minor version). After few seconds of startup screens, unit will enter in normal operation mode.

4.3 Startup sequence

Press and hold button for two seconds.

PWR LED will indicate powering up. If FlarmBat did not power up, you need to hold button longer or internal battery is empty, or external power supply is not present.

4.4 Shutting down FlarmBat

With extremely long press to the button, FlarmBat will shut down.

4.5 Normal operation

In normal operation with short press, we can cycle between three different volumes (Low, Medium and High). With long press, is enabled or disabled near mode. Switching of mode is also visually supported with moving light around circle. Red moving light means that near mode is disabled, yellow moving light means that near mode is enabled.

4.5.1 WARNING Modes:

WARNING Mode will activate a red blinking diode, if another glider equipped with Flarm will be close and a prediction for a **collision** risk is calculated. An audio warning will be also executed. Higher collision risk will increase blinking frequency and audio beep rate. The warnings are classified into three levels (See Flarm manual for details on www.flarm.com)

- First level approximately **18 seconds** before predicted collision
- Second level approximately **13 seconds** before predicted collision
- Third level approximately **8 seconds** before predicted collision

4.5.2 NEAREST Mode:

Will show the direction to the nearest glider, which's position is inside of radio range. **One** yellow LED will light **permanently** and there will be **no audio**. The unit will change over to Warning Mode **automatically, if warning** criteria will be fulfilled and will continue in NEAREST after collision risk will disappear.



Near mode works only when you are moving. On ground, you cannot see nearest target.



Near mode can be enabled or disabled with longer press to the button, during normal operation. Yellow "flying LED" around horizontal led indicator will indicate Near mode ON, Red "flying LED" around horizontal led indicator will indicate Near mode OFF.

4.5.2.1 Multi target in nearest modus

If more than one targets are in the neighbourhood, the closest target will be displayed with yellow LED permanently. All other targets will blink in yellow color. Distance and vertical angle will indicate the closest target.

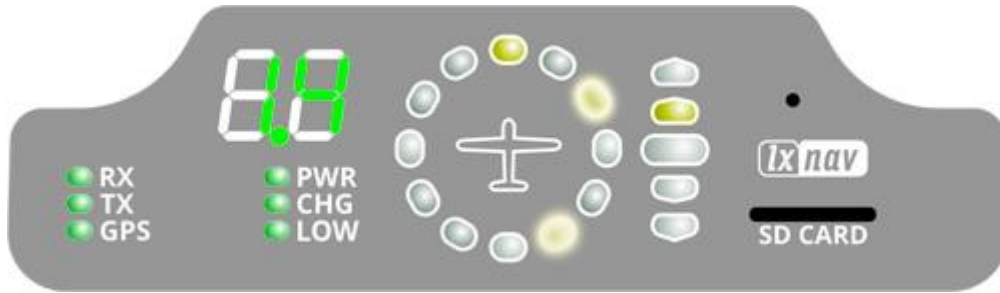

4.5.3 Obstacle warning

An obstacle warning will be activated, if an obstacle is to be found in the front of the glider and a collision risk is predicted. The warning is shown with two red LEDs, symmetrical around the 12 o'clock LED at 10 and 2, they alternate with those at 11 and 1. As we approach to the obstacle the frequency of the alternation increases.

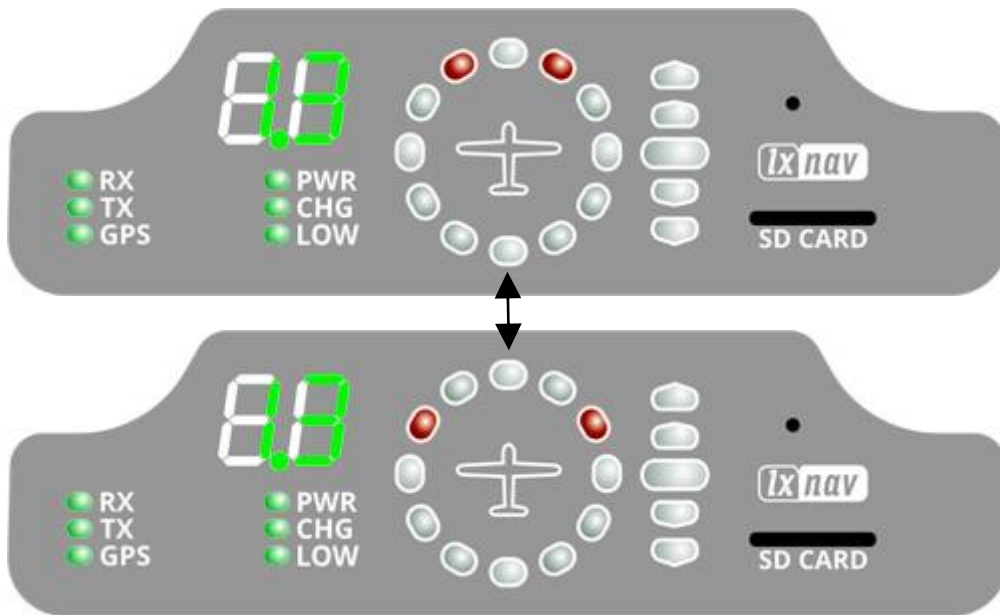

4.5.4 Undirected PCAS warning

If the FlarmLED is connected to a device, which also translates transponder signals with ADS-B data into Flarm warnings, you will receive them in the same logic as other flarm objects. Transponder signals without ADS-B data contain no direction for the threat therefore you will get an undirected warning with the following alternating signals:

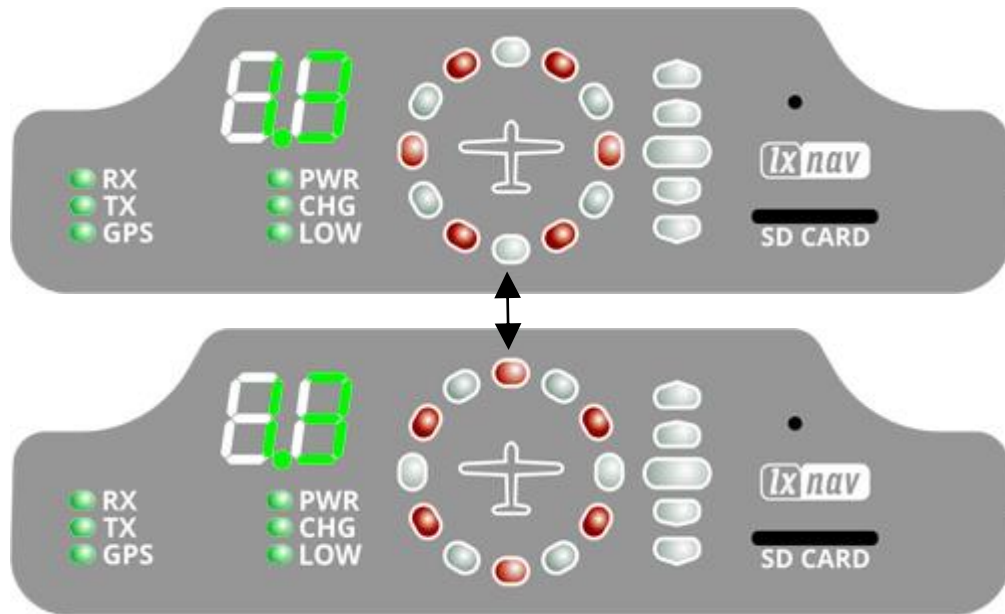

4.6 Setting up FlarmBat

If we hold the push button, during power on, LXNAV FlarmLed will go into setup mode, where following settings can be adjusted:

- Brightness of LED's
- Volume on beeper
- Near mode
- PCAS setting
- ADSB setting
- Units setting

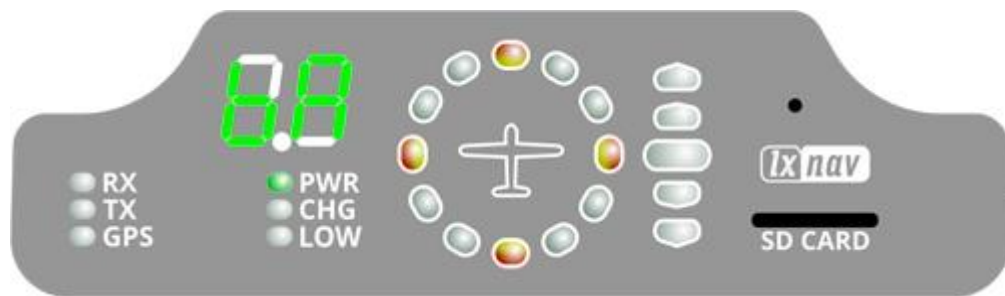

Setup mode is indicated with following horizontal indicator image:

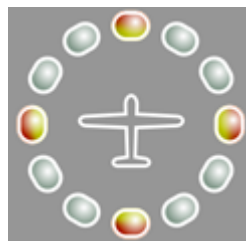

With long press to the button we are switching between different settings, which can be set. Short press will change value for actual setting.

First (left digit) indicates the setting, that we are setting, second digit (right) shows the value of that setting.

On picture below, left digit indicates character "b", right indicates character "A".



Setting	Left digit description	Right digit description
Brightness of LED's	b	A.. automatic (ALS) (default) 0.. Minimum brightness 1.. Medium - 2.. Medium + 3.. Maximum brightness
Units setting	U	0.. km (default) 1.. nm 2.. ml
Vertical indicator LED resolution	I	0.. 3° and 7° 1.. 7° and 14° 2.. 14° and 28° (default)
Decimal point	d	0.. automatic (0.0 to 99) 1.. fixed decimal point (0.0 to 9.9)
Near mode	n	0.. OFF (default) 1.. ON one target 2.. ON 2 targets 3.. ON 3 targets 4.. ON 4 targets 5.. ON 5 targets .. 9.. ON 9 targets
PCAS ⁽¹⁾	P	0.. PCAS OFF 1.. PCAS ON
ADSB display ⁽¹⁾	A	0.. OFF (default) 1.. ON
Volume on beeper	S	0.. Minimum volume 1.. Medium 2.. maximum (default)

¹⁾ Available only if ADSB is built in

ADSB display of target will be available only if NEAR mode is ON, ADSB is ON, and no closer flarm traffic available. PCAS information will be available if ADSB is set to 2, no flarm warnings present and no closer traffic, which might be sometimes very annoying.

4.7 Other indications

The FlarmBat Display can indicate some further statuses.

Left digit indicates type of the operation. Horizontal indicator indicates progress.

4.7.1 IGC-file download onto SD-card (1)

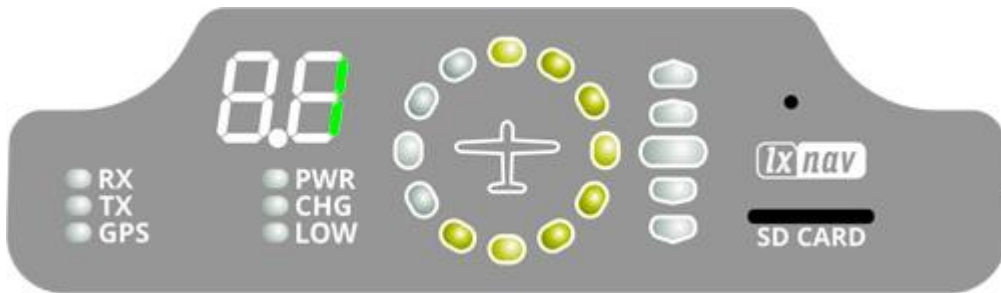

4.7.2 Running Flarm firmware update from SD-card (2)

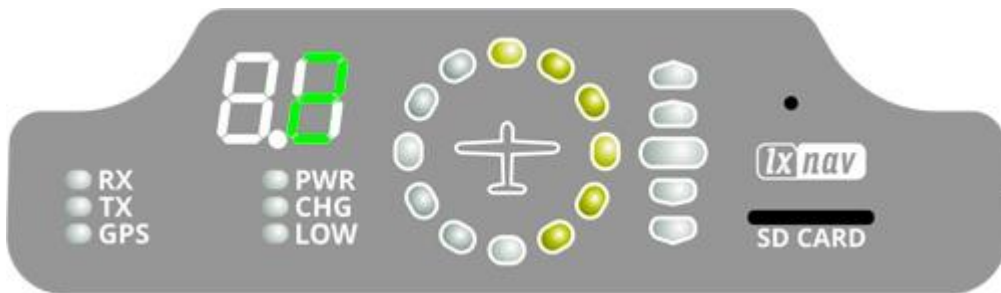

4.7.3 Obstacle database update from SD-card (3)

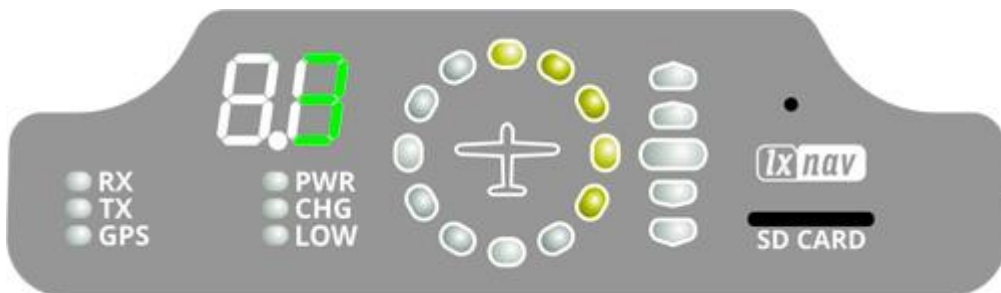

4.7.4 Diagnostic dump (4)

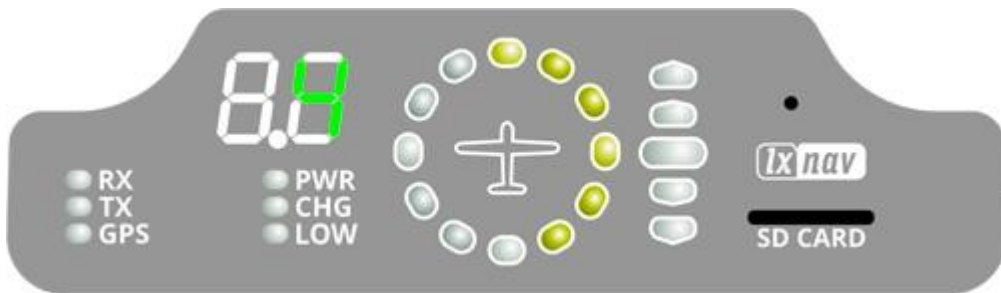

4.7.5 Restore file system (5)

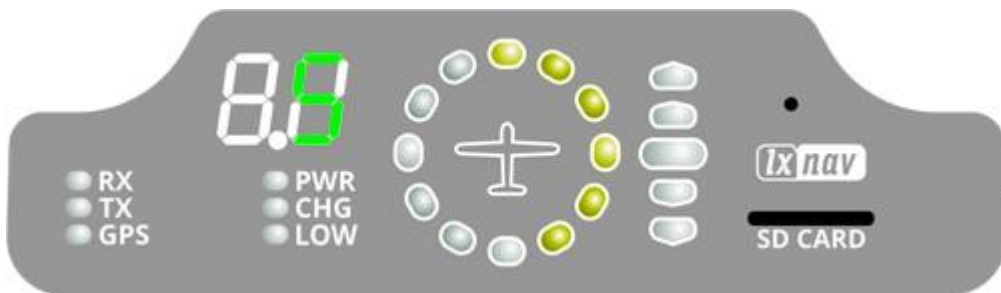

4.7.6 Internal consistency check (6)

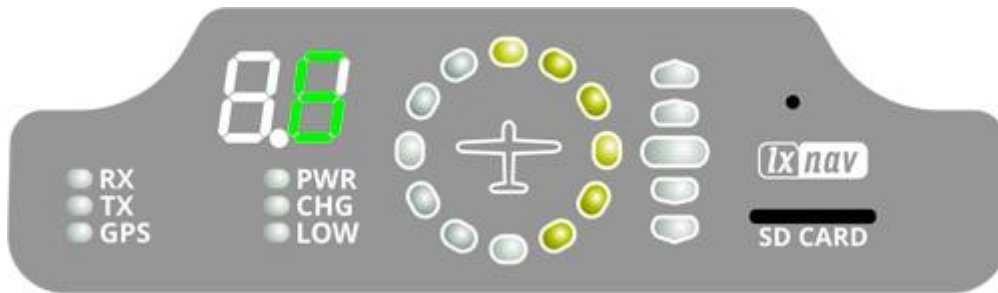

4.7.7 Error codes from flarm

If any error is present numeric display will blink with an error code.

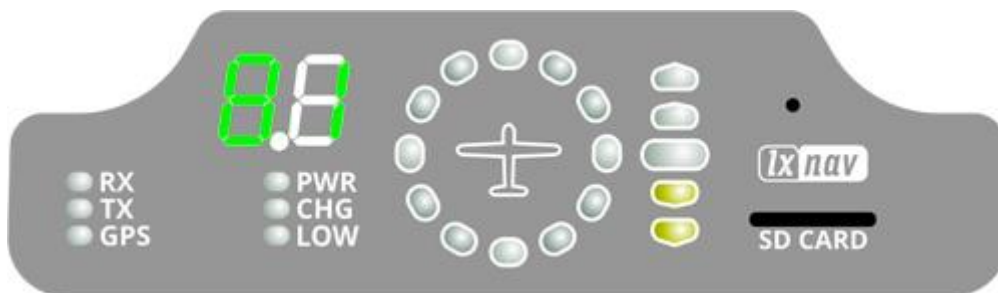

On picture below is code 81, which means No Obstacles.







Error codes are described in the list below.

- 11 = Firmware expired (requires valid GPS information, i.e. will not be available in the first minute or so after power-on)
- 12 = Firmware update error
- 21 = Power (e.g. voltage < 8V)
- 22 = UI error
- 23 = Audio error
- 24 = ADC error
- 25 = SD card error
- 26 = USB error
- 27 = LED error
- 28 = EEPROM error
- 29 = General hardware error
- 2A = Transponder receiver Mode-C/S/ADS-B unserviceable
- 2B = EEPROM error
- 2C = GPIO error
- 31 = GPS communication
- 32 = Configuration of GPS module
- 33 = GPS antenna
- 41 = RF communication
- 42 = Another FLARM device with the same Radio ID is being received. Alarms are suppressed for the applicable device.

- 43 = Wrong ICAO 24-bit address or radio ID
- 51 = Communication
- 61 = Flash memory
- 71 = Pressure sensor
- 81 = Obstacle database (e.g. incorrect file type)
- 82 = Obstacle database expired.
- 91 = Flight recorder
- 93 = Engine-noise recording not possible
- A1 = Configuration error, e.g. while reading flarmcfg.txt from SD/USB.
- B1 = Invalid obstacle database license (e.g. wrong serial number)
- B2 = Invalid IGC feature license
- B3 = Invalid AUD feature license
- B4 = Invalid ENL feature license
- B5 = Invalid RFB feature license
- B6 = Invalid TIS feature license
- 100 = Generic error
- 101 = Flash File System error
- 110 = Failure updating firmware of external display
- 120 = Device is operated outside designated region. The device does not work.
- F1 = Other

Vertical indicator shows severity levels:

fatal problem, device will not work	functionality may be reduced	information only, i.e. normal operation	no error, i.e. normal operation
			

4.8 Wiring

4.8.1 FlarmBat pinout



Pin number	Description
1	GND
2	GND
3	(input) Receive to LXNAV FlarmBat RS232 Level
4	(output) Transmit from LXNAV FlarmBat RS232 Level
5	Ground
6	3.3V power supply (output) – for external display (LED)
7	12V IN
8	12V IN

4.8.1.1 FlarmBat – FlarmView

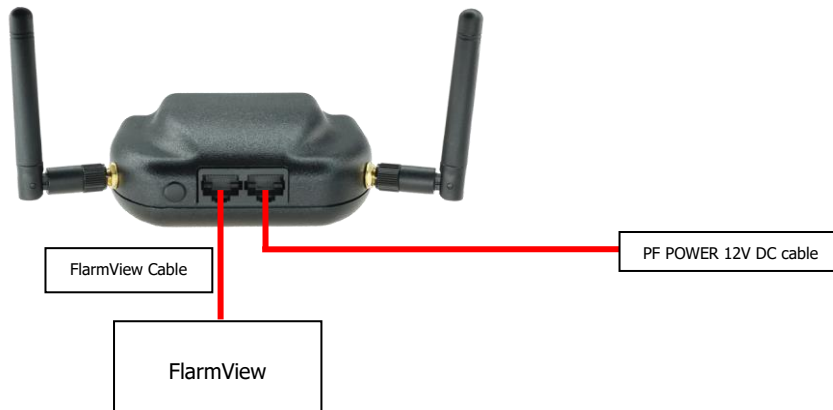

4.8.1.2 FlarmBat – FlarmLED

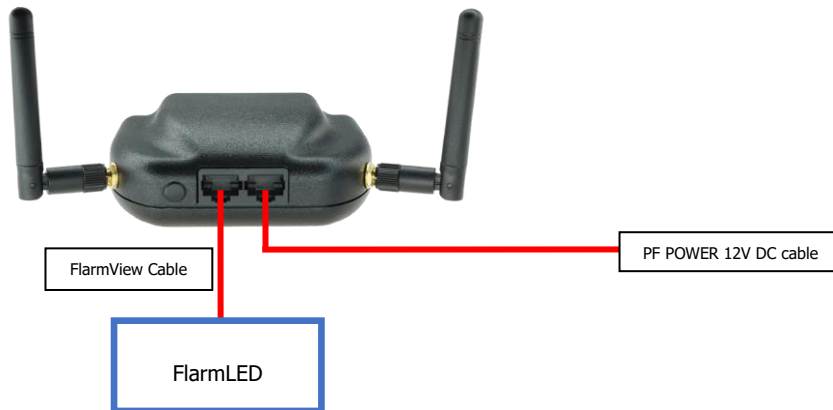

4.8.1.3 FlarmBat – FlarmLED – Oudie

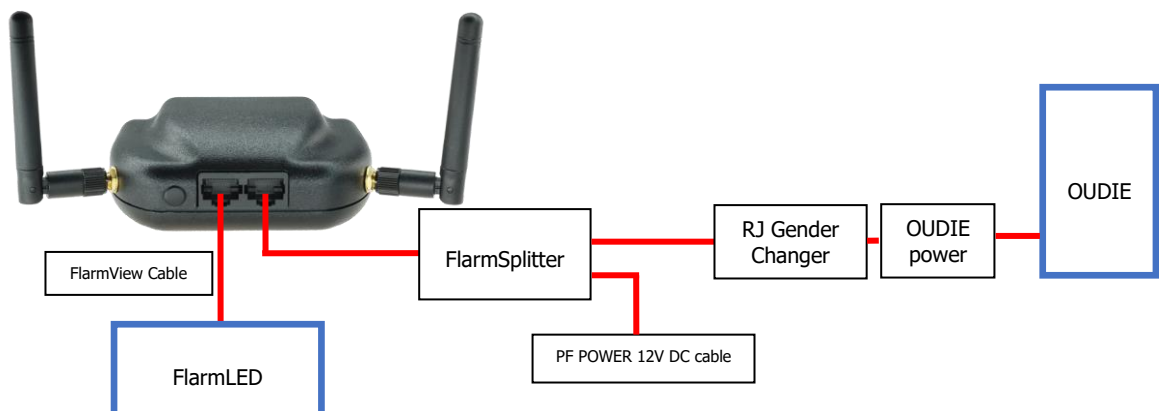

4.8.1.4 FlarmBat – FlarmView – Sxxx Vario



4.8.1.5 FlarmBat – LX9xxx – FlarmView

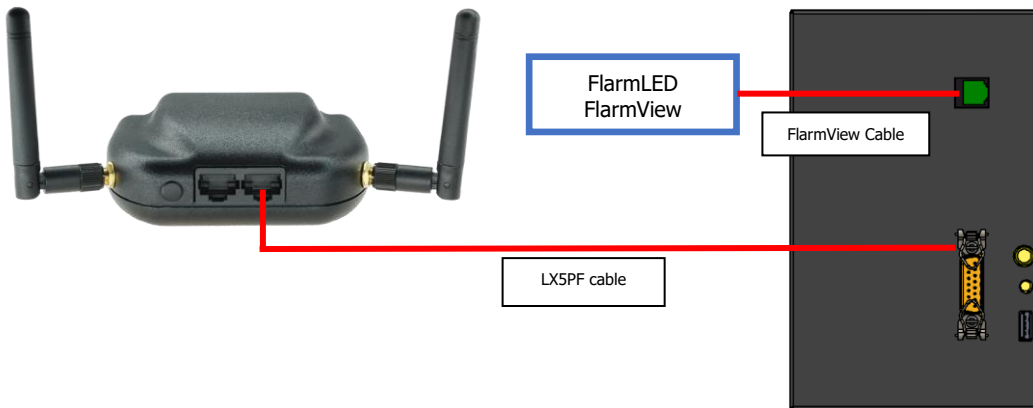

4.8.2 Flarm antenna wiring

To maximize efficiency of two Flarm antennas it is advisable to place them as far apart as possible and pointing in different directions to reduce signal blind spots. They can be both mounted on the device itself as pictured above but it is better to place one of them remotely (away from the FlarmBat), and connect it with an antenna cable).

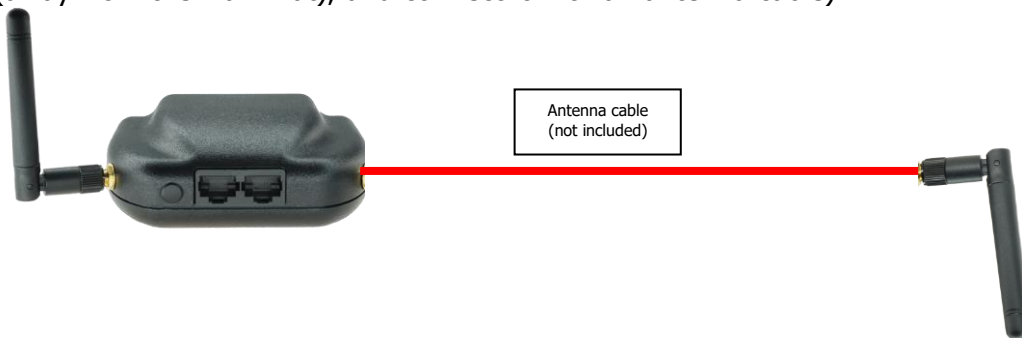

4.9 Firmware update

Flarm firmware can be updated via micro SD card. Just copy firmware to SD card, insert it and power on FlarmBat. Firmware can be downloaded on LXNAV-Downloads-Firmware section.

4.9.1 ADS-B firmware update via Flash Loader

This method is used if you wish to update an ADS-B module in FlarmBat.

You can get flash loader at: <https://gliding.lxnav.com/lxdownloads/firmware/> (S7 PC update tool) or Oudie (PNA update tool).

For the update you need file named `_x*.lxfw` (x= version nr.) on your computer.

Update procedure:

- Switch off the Flarm and connect it to your PC via Port 2.
- Select communication port to which your FlarmBat is connected to
- Select baudrate 57600
- Browse for firmware (.lxfw file)
- Press Flash
- Turn the device back on

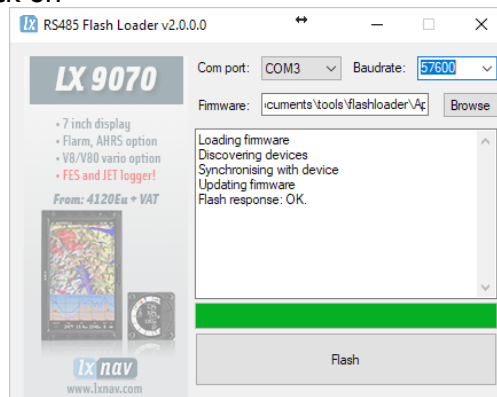

To update ADSB module, a cable Flarm update 12V DC is required and a Comm port on PC.

4.10 Configuring FlarmBat

4.10.1 Configuring FlarmBat settings PowerFlarmConfig

PowerFlarm config is available in download section of our web page:

<https://gliding.lxnav.com/lxdownloads/software/>

Here you can set all settings for your FlarmBat device. File will be saved as flarmcfg.txt file, which you should save on the micro SD card. To load this file into FlarmBat, insert micro SD card in FlarmBat and switch it ON. File will be automatically loaded into device. You can configure existing flarmcfg.txt, which is present on micro SD card.

4.10.2 FlarmBat configuration by using Flarm configuration tool

FlarmBat can be configured by Flarm Tool software which can be found here:

<https://flarm.com/support/tools-software/flarm-configuration-tool/>



In Flarm tool are not supported all features, that can be configured for FlarmBat.

Q Search ... ABOUT US JOBS LOG IN ENGLISH

FLARM PRODUCTS SOLUTIONS TECHNOLOGY BUY NEWSROOM SUPPORT

HOME - SUPPORT - TOOLS & SOFTWARE - FLARM CONFIGURATION TOOL

FLARM CONFIGURATION TOOL

When installing FLARM in an aircraft, and before using a portable FLARM, it is very important that it is configured correctly. Use the configuration tool below to configure your device. After selecting the desired options, the configuration file is instantly downloaded.

Note that the configuration tool only works with the latest released firmware version. Before configuring the device, you need to update to the latest firmware version, independently of when you did the last firmware update.

We take the privacy of your data seriously and you can find our Privacy policy [here](#).

My devices
Log in to see your devices

New device
Manufacturer: LXNAV

Device: FlarmBat

START CONFIGURATION

BLOG

- **2019-01-31** New 2019 Obstacle Data Available
MORE
- **2019-01-07** Fully-automated long-range UAV flights
MORE

Obstacles 2019

The updated Obstacle databases for 2019 are now available in our shop.

Create Config file:

- Select "New device" and choose "LXNAV" and "FlarmBat"
- Click on the button: Start configuration

Edit configuration file:

- After pressing button described above multiple options will show.
- Configure and adjust them to your liking
- More settings are available by checking "Show advance settings"

Show advanced settings

ICAO 24-bit aircraft address, hexadecimal
Official 24-bit ICAO aircraft address in hexadecimal notation, as issued by local CAA. It consists of six hexadecimal characters (0-9, a-f) and can be obtained from the aircraft papers. Must match the address configured in the Mode-S transponder. If the aircraft does not have a Mode-S transponder, it's possible to leave the field empty to use the device specific radio id. Enter "0" (zero) for random id (not recommended, will make Search and Rescue (SAR) very difficult).

Aircraft type
The configured aircraft type will influence motion prediction and collision risk algorithms and warnings for both the own aircraft as well as other aircraft. Ensure that you select the correct type.

Data sentences on data port 1
According to instructions from the display/equipment manufacturer.

Protocol version for data port 1
"Version 4" is typically supported by all displays. Select a higher version if the display supports it to have access to all functions. Select "Version 3" if Data sentences is configured as Garmin TIS.

Baud rate for data port 1
Baud rate (bit rate). Must match setting in attached display/equipment. Select at least 19200 for advanced functions.

Protocol version for data port 2
Protocol to be used. "Version 4" is typically supported by all displays. Select a higher version if the display supports it to have access to all functions.

Baud rate for data port 2
Baud rate (bit rate). Must match setting in attached display/equipment. Select at least 19200 for advanced functions.

Transponder type
Type of transponder that is installed in the aircraft.

CREATE CONFIG FILE

Edit advance settings:

- Do this the same way as described above for standard settings

Logging interval (seconds)
Applicable for IGC flight recording.
4 (Default) ▼

Remove all IGC files?
Deletes all IGC files from the device. Restarts the device.
 Yes
 No (Default)

Remove obstacle database?
Deletes the obstacle database (if installed) from the device. Restarts the device.
 Yes
 No (Default)

Pilot name
Applicable for IGC flight recording.

Co-pilot name
Applicable for IGC flight recording.

Glider ID
Applicable for IGC flight recording.

Glider type
Applicable for IGC flight recording.

Competition class of glider
Applicable for IGC flight recording.

Competition ID
Applicable for IGC flight recording.

Stealth mode
Hides tactically relevant flight data for usage at competitions. Receiving stations may use the received data for the purposes of traffic safety only or with a time delay of 10 minutes. Tactical data like climb rate are omitted or randomized.
 Enable
 Disable (Default)

No-Track mode
Enhanced privacy mode. Receiving stations may use the received data for the purposes of traffic safety only. If enabled, Search and Rescue (SAR) based on data received by ground stations is not possible.
 Enable
 Disable (Default)

Create config file:

- Click button "Create config file"
- File (FLARMCFG.txt) will automatically be downloaded to your computer



To load this file into FlarmBat, copy it on micro SD card, insert it into FlarmBat and switch it ON. File will be automatically loaded into device.

4.11 Saving flight on the micro SD card

The last 20 flights will be downloaded at every switching on (only if the micro SD card is inserted). If there are already some of the 20 flights on the Micro SD card, they will not be downloaded again. That means: if you have been flying a lot without downloading flights, the download procedure will take some time, so don't switch off. To download one flight after landing perform the following procedure: Wait a 3 minute after landing. Then switch off power for at least 5 sec. Insert the Micro SD card (in case it's not already inside) and switch on again.



The collision avoidance functionality does not depend on the status of the Micro SD card (inserted or not)

5 Revision History

October 2018	Initial release of this manual
November 2018	Corrected some misprints
February 2019	Updated chapter: 4.10.2 Removed chapter: 4.10.3 Added chapter: 4.8.2